

SERIES 616W | DIFFERENTIAL PRESSURE TRANSMITTER

FEATURES/BENEFITS

- NEMA 4X rated enclosure provides protection in harsh environments permitting outdoor monitoring or in areas where dust and particulate matter exists
- Easy to read LCD display provides immediate local alerts allowing corrective action to be taken quicker to eliminate the problem from becoming widespread
- Zero and span controls provides easy calibration checks and shorter installation time to get device running and monitoring

APPLICATIONS

- Dust collection
- Outdoor HVAC
- Roof-top equipment

DESCRIPTION

Positive, negative and differential pressures can be measured within a full span accuracy of ± 0.25 with the **SERIES 616W** Differential Pressure Transmitter. Units are enclosed in a polycarbonate case, rated NEMA 4X (IP66) and operate by sensing the pressure of air and compatible gases then sending a standard 4-20 mA output signal. Design enables operation in 2-wire current loops. A wide range of models are available factory calibrated to specific ranges. The span and zero controls are for use when checking calibration. They are not intended for re-ranging to a significantly different span. The LCD display allows local indication of pressure.



SPECIFICATIONS

Service	Air and non-combustible, compatible gases.
Wetted Materials	Consult factory.
Accuracy	$\pm 0.25\%$ FS @ 77°F (25°C), display accuracy $\pm 0.5\%$.
Stability	$\pm 1\%$ FS/yr.
Temperature Limits	14 to 185°F (-10 to 85°C).
Pressure Limits	See model chart on catalog page.
Power Requirements	10 to 35 VDC (2-wire), 17 to 36 VDC, or isolated 21.6 to 33 VAC (3-wire).
Zero and Span Adjustments	Push buttons.
Loop Resistance	Current output: 0 to 1250 Ω max; Voltage output: load resistance 1 k Ω (min).
Current Consumption	40 mA (max).
Electrical Connections	3-wire removable European style terminal block for 16 to 26 AWG.
Process Connections	Barbed, dual size to fit 1/8" and 3/16" (3.12 and 4.76 mm) ID rubber or vinyl tubing.
Enclosure Rating	NEMAX 4X (IP66).
Mounting Orientation	Any orientation.
Weight	Without LCD 8.8 oz (249 g); with LCD 9.6 oz (272 g).
Agency Approvals	CE.



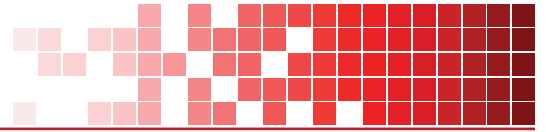

DIMENSIONS

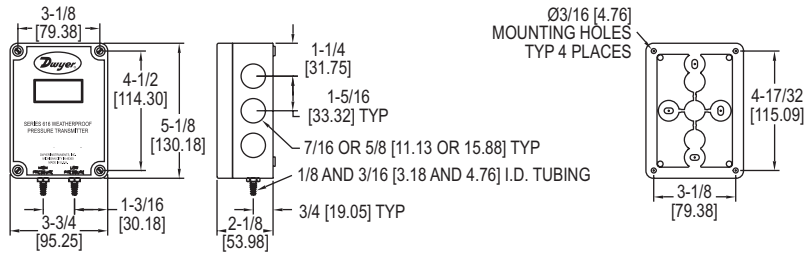

WIRING DIAGRAM

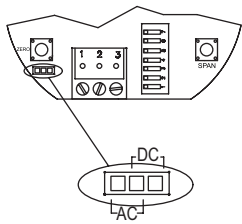

AC/DC Jumper

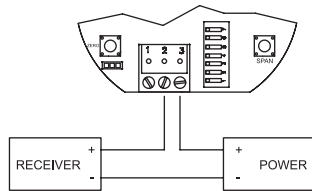

Current Output Wiring

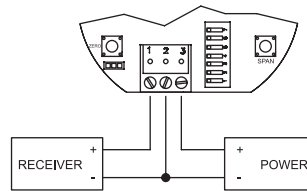

Voltage Output Wiring

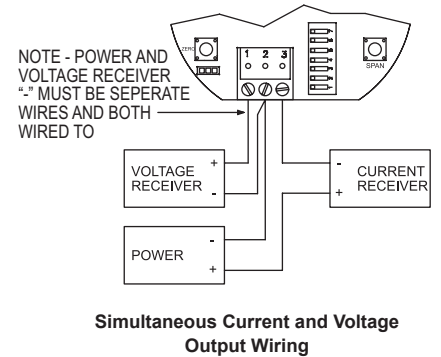

Simultaneous Current and Voltage Output Wiring

HOW TO ORDER

Use the **bold** characters from the chart below to construct a product code.

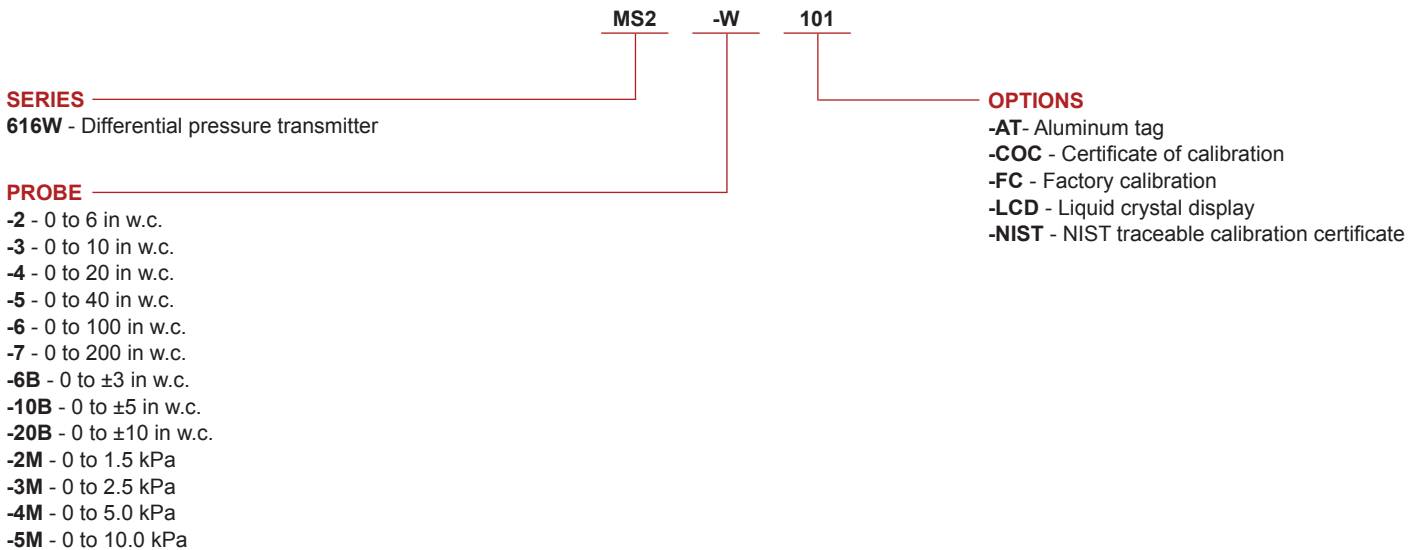

Important Notice: Dwyer Instruments, Inc. reserves the right to make changes to or discontinue any product or service identified in this publication without notice. Dwyer advises its customers to obtain the latest version of the relevant information to verify, before placing any orders, that the information being relied upon is current.

